



Install Guide







©2016 Incredible Technologies, Inc. All Rights Reserved

Using this Guide

The following icons are used to highlight specific areas of interest and to indicate when extreme caution is necessary to avoid product damage or bodily injury:

Common Symbols

	<p>Caution</p> <p>Indicates that there is a chance for damage to components or equipment.</p>
	<p>Danger</p> <p>Indicates that there is a chance of physical harm or even death to the operator.</p>
	<p>High Voltage</p> <p>Indicates presence of voltages equal to or exceeding 50 volts, which can cause dangerous amounts of current to flow through a person touching two points of a circuit.</p>
	<p>Note</p> <p>Indicates specific instructions for optimum performance during a procedure or usage tips.</p>

[IT Support - Manuals](#)

This Install Guide is one of four guides IT uses to help operators better understand our videmption cabinets. Visit <http://amusement.itsgames.com/service/manuals> to see the Operator Menus Guide once installation is complete.

Tickle Monsters

Quick Start Guide	Instructions for setting up the game cabinet
Install Guide	Instructions for setting up the game cabinet, warranty information, care and cleaning, customer support
Operator Menus Guide	Instructions for menus that set game controls: Audits, Adjustments, Tests, Licenses and Reset Menu
Wiring Diagram	Schematic displaying the electrical wiring inside the cabinet

Safety Precautions and Warnings

Following are some basic safety precautions to take when handling the redemption game cabinet.

WARNING



- DO NOT handle cords, wiring, any exposed outlets or other electrical devices inside the machine with wet hands. Doing so could cause an electrical shock.
- When servicing this game cabinet, the service technician needs to be properly grounded. Use a wrist or heel strap with the ground wire attached to the nut of the grounding wire located at the base of the PDU. Failure to ground could damage sensitive electrical components.
- The gaming device is heavy and weighs over 200 lbs. To prevent injuries when moving or lifting, make sure to use at least two people.



- Tipping, shaking or rocking the cabinet may cause injury.
- Surfaces inside the cabinet can become hot during operation. Use caution whenever opening the machine to perform maintenance.
- If the gaming device becomes hot, blows smoke, or generates an unusual odor, immediately turn OFF the power and unplug the machine from the AC power outlet. Call Incredible Technologies' [Customer Service](#).
- If the power supply cord is damaged, it must be replaced by the manufacturer, its service agent or similarly qualified persons in order to avoid a hazard.
- Use of unauthorized parts or making any unauthorized modifications will void the warranty and may result in the game operating in an unsafe or incorrect manner.

Warranty and Service Policies

Legal Liability Notice

This game must be operated in such a manner as to avoid violating any federal, state, or local laws or regulations. As the owner and/or operator of this game you are responsible for its operation in compliance with such laws and regulations. The factory settings for this game may require adjustment in order to comply with the laws and/or regulations in the jurisdiction where the game is located. It is the sole responsibility of the operator to determine what laws and/or regulations are applicable before operating it for its intended purpose, and to ensure that the game has been appropriately configured.

Notice

This guide and the information contained within is subject to change without notice.

Warranty and Repair Policy

- There is a minimum service charge for all non-warranty repairs or returns. Inquire at time of service for current fee.
- For all servicing, return the game cabinet to Incredible Technologies, Inc.
- ANY non-factory repair or attempted repair voids warranty.
- Warranty may be void if serial number or security labels are tampered with or removed.
- Advance replacement hardware will be shipped to the customer address on file unless specified otherwise.
- Advance replacement hardware will be billed to the customer until Incredible Technologies, Inc., receives the returned merchandise, at which time a credit will be issued.
- All repairs and/or replacements will ship as soon as possible after receipt or request (subject to availability).
- If the original purchaser discovers any physical defect in the media on which the software is distributed or in the documentation, which in the opinion of Incredible Technologies, Inc. (IT) prevents the product from being used as reasonably intended, IT will replace the media or documentation at no charge. The purchaser must return the item to be replaced, with proof of purchase, to IT within 90 days after taking delivery of the software.
- IT warrants to the original purchaser that the hardware product is in good working condition for a period of 90 days from taking delivery of the product. Should this product, in IT's opinion, malfunction within the warranty period because of a defect in design, materials, or workmanship, IT will repair or replace this product without charge under the terms as follows. Replacement of either the hardware product or its component parts will be only on an exchange basis. Any replaced parts or components become the property of IT. This warranty does not apply to those products that have been damaged due to accident, abuse, improper installation, natural disaster, or unauthorized repairs or modifications.



- IT excludes any and all implied warranties, including warranties of merchantability and fitness for a particular purpose, and limits the purchaser's remedy to returning the software, hardware, or documentation to IT for replacement.
- IT makes no warranty or representation, either express or implied, with respect to this software, hardware, or documentation, their quality, performance, merchantability, or fitness for a particular purpose. This software, hardware, and documentation are licensed "as is," and the purchaser/licensee assumes the entire risk as to their quality and performance.
- In no event will IT be liable for direct, indirect, special, incidental, or consequential damages arising out of the use or inability to use the software, hardware, or documentation, even if advised of the possibility of such damages. The warranty and remedies set forth above are exclusive and in lieu of all others, oral or written, express or implied. No person, seller, dealer, agent, or employee is authorized to make any modification or addition to this limited warranty.
- Some states do not allow the exclusion of implied warranties or liability for incidental or consequential damages, so the above limitation or exclusion may not apply to you. This warranty gives you specific legal rights, and you may also have other rights that vary from state to state.



Contents

Preface

Using this Guide	i
Safety Precautions and Warnings	ii
Warranty and Service Policies	iii

Contents

Table of Contents	1
-------------------	---

Getting Started

Cabinet Contents	2
----------------------------------	---

Cabinet Diagrams

Exterior Components	3
System Box	4
Carrier Board	5

Cabinet Setup

Mounting HDTV Monitor	6
Mounting Marquee Topper	8
Installing Peripherals	10

Maintenance

Cabinet Temperature	14
Care and Cleaning	14

Customer Service

IT Sales, Service, and Customer Support	15
---	----

Cabinet Contents

Marquee Topper Sub Assembly:

- (1) Marquee Topper with power cord
- (2) Marquee Braces (attached)
- (2) 8-32 x 3/8" Hex Nuts
- (2) 8-32 x 3/8" Hex Screws
- (1) Tickle Monsters CFast Card
- (1) Security Key Fob

HDTV Monitor Sub Assembly:

- (1) HDTV Monitor Mounting Brackets
- (2) 8-32 x 3/8" Hex Screws
- (4) M8 Mounting Plate Bolts
- (4) Mounting Plate Flat Washers
- (4) Mounting Plate Lock Washers
- (1) Bridge Lance
- (1) Cable Tie

46" HDTV Monitor with power cord

Impact Cabinet with Peripherals:

- (1) Power Cord
- (1) HDMI Cable
- (1) USB Touch Screen cord
- (1) Quick Start Guide
- (1) Swipe Card/Tokens/Coins Stickers
- (2) Card Reader Plates
- (1) Blanking Plate

Specifications

IMPACT Cabinet with Stand
Length: 31 inches
Width: 45 inches
Height: 93 inches
Weight: 300 pounds



Cabinet Diagrams

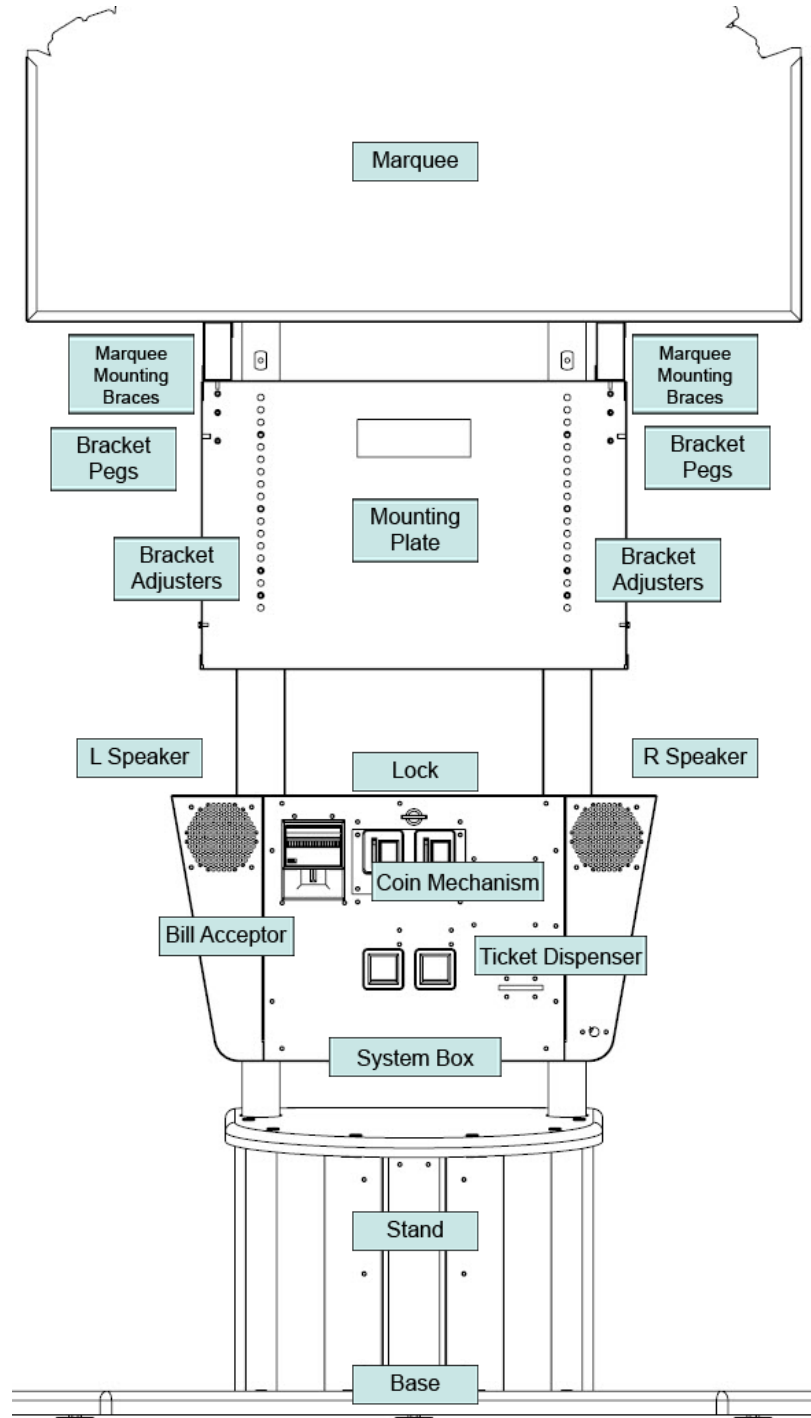

Exterior Components - Front

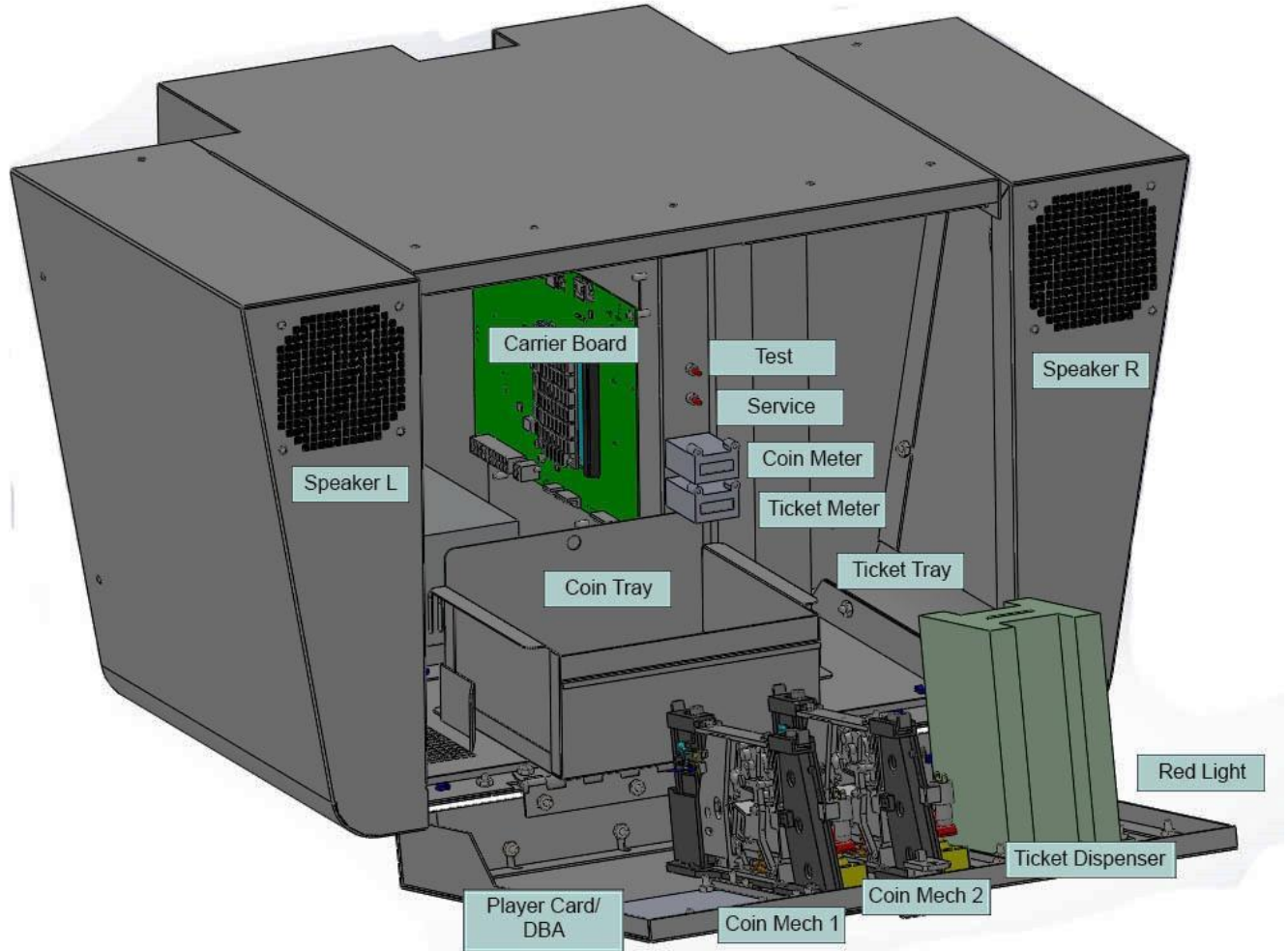

System Box

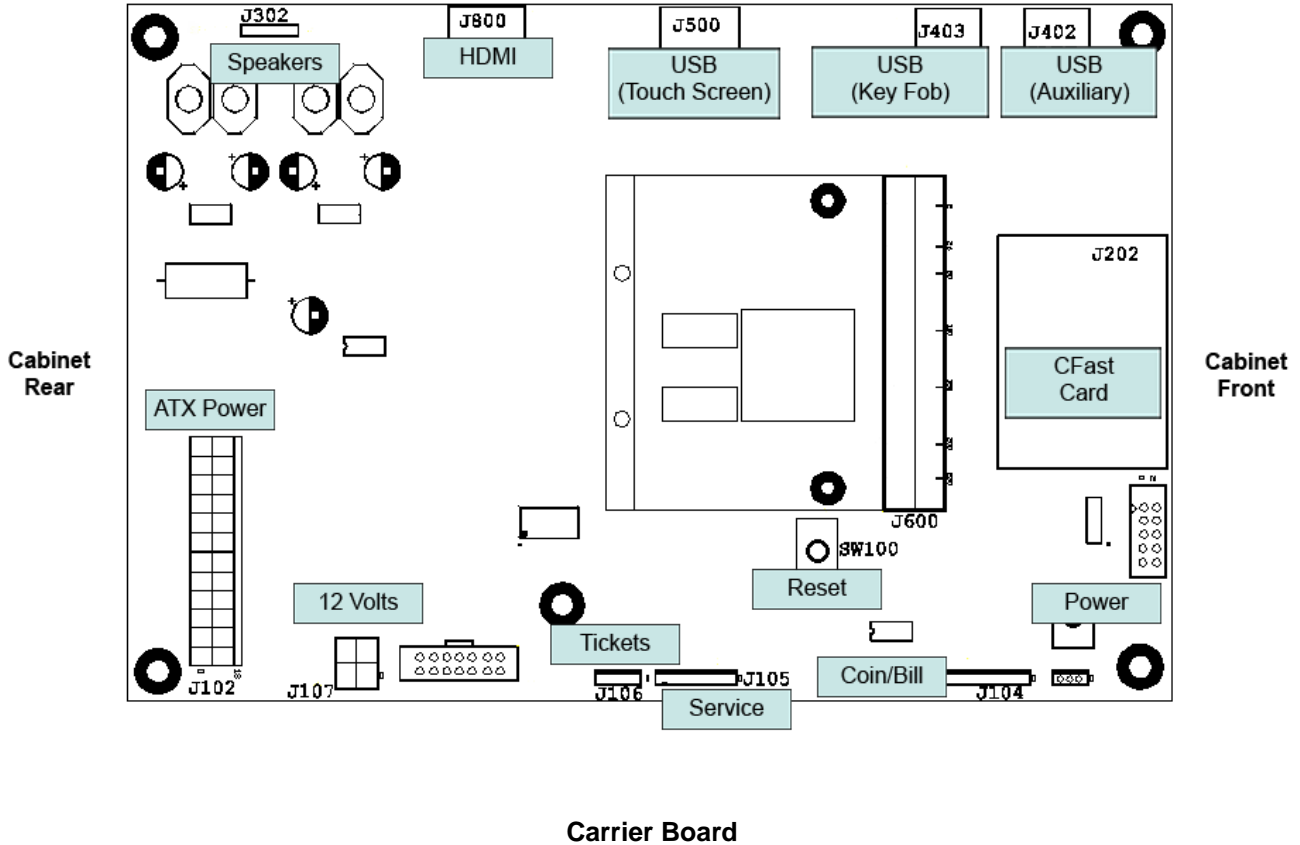

Mounting HDTV Monitor

Materials required:

- | | |
|------------------------------------|--|
| (2) HDTV Monitor Mounting Brackets | (4) Mounting Plate Lock Washers |
| (2) 8-32 x 3/8" Hex Screws | 11-32" Nut Driver or Phillips Head Screwdriver |
| (4) M8 Mounting Plate Bolts | |
| (4) Mounting Plate Flat Washers | |



It is critical to use extreme caution while mounting the HDTV to the cabinet. To prevent injuries when moving or lifting, make sure to use at least two people.



Do **NOT** attempt to mount the HDTV Monitor before mounting the Marquee Topper.



Before mounting the HDTV Monitor to the cabinet you must attach the Mounting Brackets to the HDTV Monitor.

Mounting HDTV Monitor Procedure

- 1 Using the four M8 Mounting Plate Bolts, attach the two Mounting Brackets to the HDTV Monitor. See circles in image below for location of bolts.
- 2 Finish the bolts with the four Mounting Plate Flat Washers and four Mounting Plate Lock Washers.

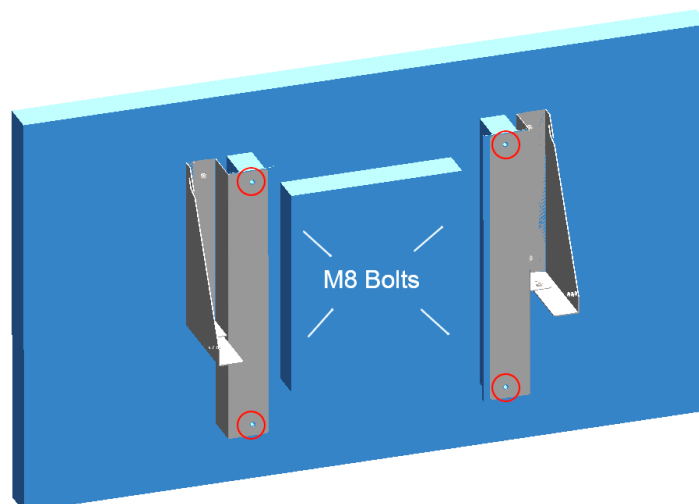

Mounting HDTV Procedure



Each Mounting Bracket has a hinge on the side that attaches to a peg on the cabinet. See image below.

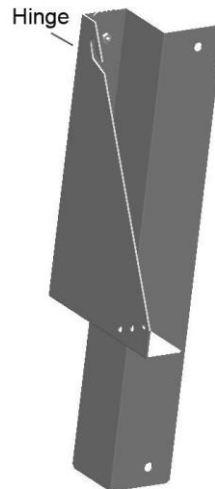

- 3 With a minimum of two people lift the HDTV Monitor into position, aligning the hinges on each side of the Mounting Brackets with the pegs on the cabinet.
- 4 Using two 8-32 x 3/8" Mounting Hex Screws, secure the Mounting Bracket to the mounting plate on each side of the cabinet.

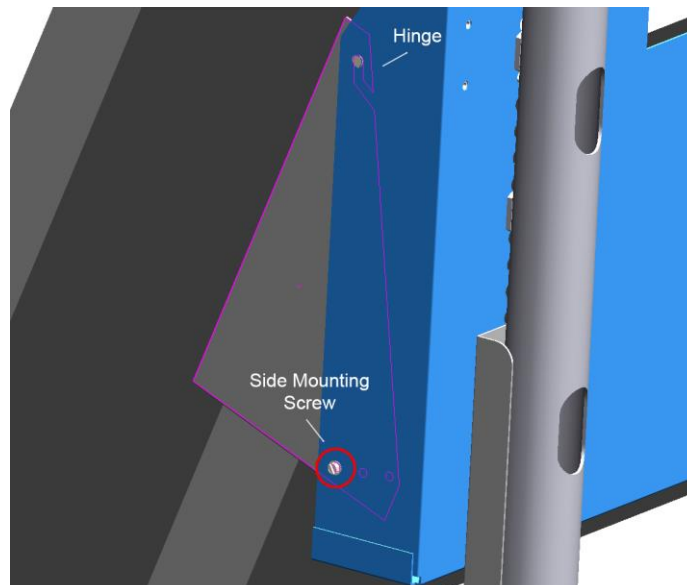

Mounting Marquee Topper

Materials required:

- (2) 8-32 x 3/8" Hex Nuts
- (2) 8-32 x 3/8" Hex Screws
- 11-32" Nut Driver or Phillips Head Screwdriver



Do **NOT** attempt to mount the HDTV Monitor before mounting the Marquee Topper.



Make sure the cabinet is unplugged and the power is OFF.

Mounting Marquee Topper Procedure

- 1** Remove the packing paper and the clear acrylic artwork from the front of the Marquee Topper, careful not to pull out any of the wires connected to the LED lights.
- 2** With a minimum of two people lift the Marquee Topper into position on top of the cabinet and carefully slide it onto the pegs protruding from the Marquee Mounting Brace. See image below.

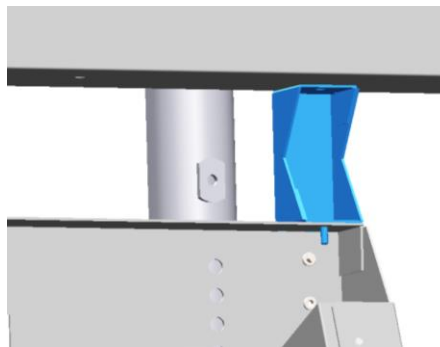

- 3** Attach one 8-32 x 3/8" Hex Nut to each peg and turn until tightened.

Mounting Marquee Topper Procedure

- 4 On the back of the cabinet, attach one 8-32 x 3/8" Marquee Hex Screw through the Marquee Brace and Topper on each side.

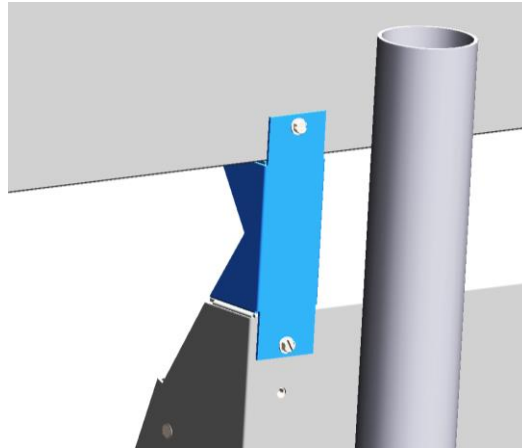

- 5 Remove the clear plastic coating from the front of the acrylic artwork. Lift the artwork into the pre-secured L-supports within the Marquee Topper.
- 6 Feed the Marquee Topper power cord through the top opening in the hollow tube of the support column and out the bottom opening.

Installing Peripherals

- (1) HDTV Monitor power cord
- (1) HDMI cable
- (1) USB Touch Screen cord
- (1) Bridge Lance
- (1) Cable Tie
- (1) Tickle Mosnters CFast Card
- (1) Security Key Fob



Make sure the cabinet is unplugged and the power is OFF.

Installing Peripherals Procedure

- 1** On the underside of the HDTV Monitor attach the HDMI cable to the far left HDMI port. Also attach the USB Touch Screen cord and the HDTV Monitor power cord. See image below.

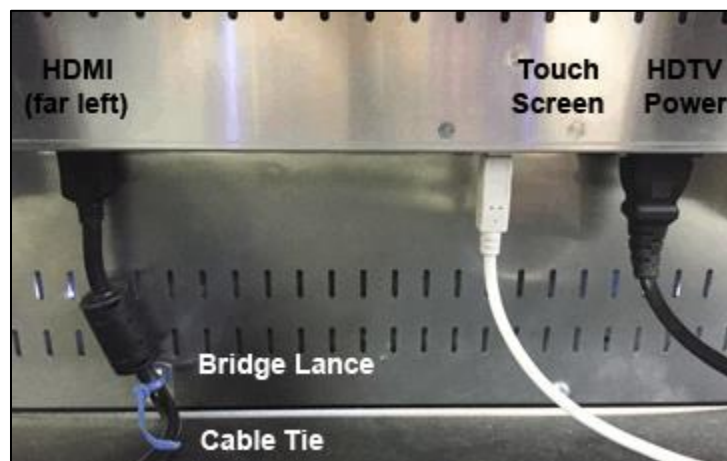

- 2** Remove the small screw below the HDMI port and attach the Bridge Lance with the same screw. Feed the Cable Tie through the Bridge Lance and wrap the Cable Tie around the HDMI cable and zip closed.



The Bridge Lance and Cable Tie hold the HDMI cord in place to prevent it from coming loose during game play

Installing Peripherals Procedure

- 3 Open the System Box (image below) from the front of the cabinet. Look for the Backing Plate at the back of the box. Remove the two 8-32 x 3/8" Hex Nuts and feed the HDMI cable and USB Touch Screen cord through the cable pass through. At this time also feed the Marquee Topper power cord through the pass through.

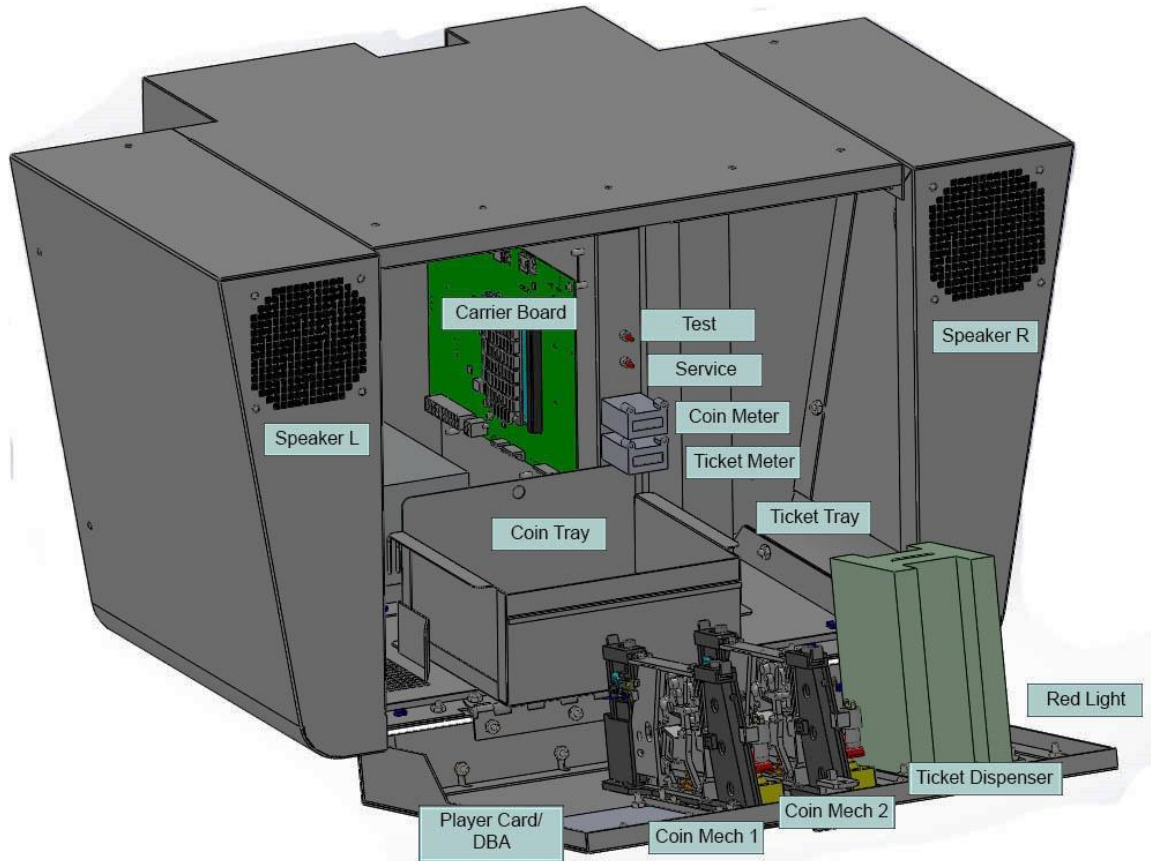

Installing Peripherals Procedure

- 4 Re-attach the Backing Plate to the pass through at the back of the System Box.
- 5 Plug the Topper power cord into the ATX power supply cord. (It has four yellow/black/black/red wires that meet in a white plug.) See image below.

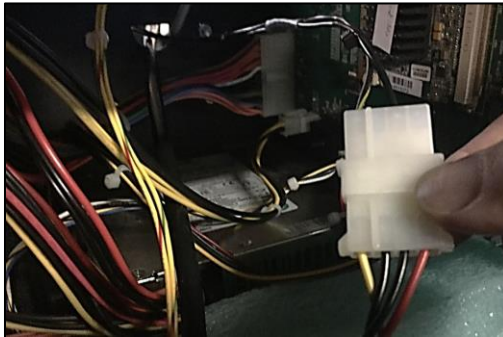

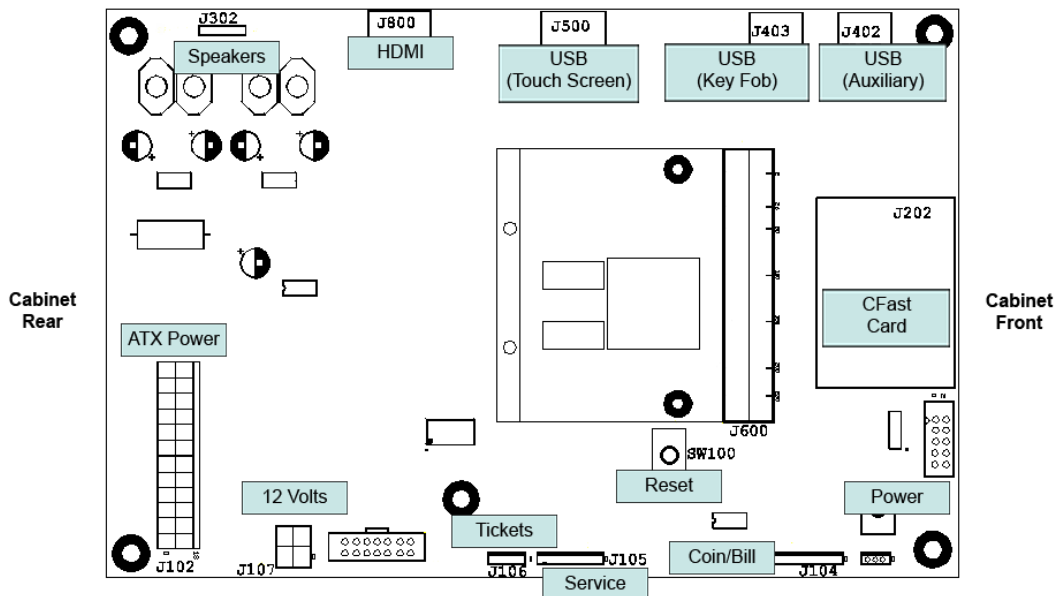

Locate the green Carrier Board mounted on the interior right side of the System Box. Along the top edge of the Carrier Board there are several USB ports and an HDMI port. See image below.



- 6 Attach the HDMI cable to the HDMI port (J800) on the Carrier Board. Attach the USB Touch Screen cord to the USB Touch Screen port (J500) on the Carrier Board.

Installing Peripherals Procedure

- 7** Attach the USB Touch Screen cable to the USB Touch Screen port (J500) on the Carrier Board.
- 8** Attach the Security Key Fob the USB port (J403). This Key Fob authenticates your software. **Do not remove it. Your game will not run without it.**
- 9** Insert the CFast Card with the game software to the CFast slot (J202) just below and to the right of the Key Fob.
- 10** Plug in the HDTV Monitor to a power source. Attach the Impact cabinet power cord to the back of the cabinet and also plug in to a power source. Turn ON the cabinet. The game should boot up immediately and be ready to play in a few minutes.
-  When the power on the back of the cabinet is turned ON, the Marquee Topper automatically illuminates.
- 11** Check to make sure the game is working and that all of the touch points on the screen work. To make any adjustments in the Operator Menus press the red Test button above the coin meter. For the Operator Menus Guide, visit our web site at: <http://amusement.itsgames.com/service/manuals>
- 12** Power OFF the cabinet and install the Player Card/DBA peripheral for your device.
- 13** Attach the stickers for Tickets and Swipe Card/Tokens/Coins in the appropriate positions on the outside of the System Box.
-  When tickets are running low, the red light on the outside of the cabinet illuminates.
- 14** Remove the protective film from the acrylic artwork on the Marquee Topper.

Maintenance

Cabinet Temperature

The hardware in the gaming device is extremely powerful and generates a substantial amount of heat. Measures have been taken to keep the various components cool during normal use. If overheating occurs, game play and hardware longevity may be affected. Use the **Tests>Thermal Tests** menu in the Operator Menus to monitor the temperature in the cabinet. Keep all ventilation openings clear of blockage, dirt and debris.

Care and Cleaning

Amusement games in good working condition, with clear monitors, clean control panels and working buttons attract players more than a machine in poor condition. It is definitely worth the time and attention to protect your investment with common care. Each week, clean the display and wipe down the button panel to bring back that new game look. Test the buttons and touch screen regularly to make sure they are playing properly. Most importantly, make sure the bill acceptor and ticket printer are in good working order.

Clean the cabinet using a mild soap and water solution or blue window cleaner. Dust and dirt can be a major cause to overheating and will lead to costly repairs. At least once a month, check to make sure the cabinet and chassis fans are working and free of dust and debris. Use a vacuum to clear all the ventilation holes on the cabinet.

Cleaning Tips for the Tickle Monsters Impact Cabinet

- To avoid risk of electric shock remember to turn off power before cleaning.
- Do not use alcohol (methyl, ethyl or isopropyl) or any strong solvent. Do not use thinner or benzene, abrasive cleaners or compressed air.
- Hard blasts of compressed air can possibly dislodge internal components. It can also be dangerous for the operator as debris may enter eyes or irritate the skin. Compressed air can contain water or oils that may cause further damage to the cabinet.
- To clean the display unit cabinet use a cloth lightly dampened with a mild detergent.
- Never apply the cleaner directly on the touch screen. To clean the touch screen use window or glass cleaner. Put the cleaner on the cloth and wipe the touch screen.



Customer Service

IT Sales and Service

To purchase additional game platforms or any of IT's other fine amusement products please visit IT's website at <http://amusement.itsgames.com/>

Technical Support & Operator Services:

If your IT amusement game is in need of repair, or you just have a technical question, call Technical Support:

Amusement Technical Support

7AM - 6PM CST, M-F

(847) 870-7027 x380

Toll Free

(800) 262-0323

Email: support@itsgames.com.

IT Mailing Address:

Incredible Technologies, Inc.
200 Corporate Woods Parkway
Vernon Hills, IL 60061



Incredible Technologies, Inc.
200 Corporate Woods Parkway
Vernon Hills, IL 60061

Phone (847) 870-7027 (800) 262-0323

<http://amusement.itsgames.com>

©2016 Incredible Technologies, Inc. All Rights Reserved. Non-IT trademarks are the properties of their owners and used for illustration only. Unauthorized duplication or disclosure may violate applicable laws or agreements.